



Innovative Science and Technology in Mechanical Engineering for Industry 4.0
The 4th International Conference on Mechanical Engineering
(ICOME 2019)



Certificate of Participation

This is to certify that

Stefan Mardikus, Malfin and I Made Wicaksana Ekaputra

have presented a paper

Flow Structure Investigation Heat Transfer Enhancement on Inner Tubular Pipe with
Winglet Vortex Generator

at the conference, organized by the **Department of Mechanical Engineering, Institut Teknologi Sepuluh Nopember (ITS) Surabaya**, in Yogyakarta, Indonesia on 28 - 29 August 2019.

Acting Head of Department

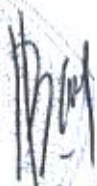

Dr. Bambang Sudarmanta
NIP. 197301161997021001

Chairman of Conference



Fahmi Mubarak, Ph.D
NIP. 197801152003121002

**Innovative Science
and Technology in Mechanical
Engineering for Industry 4.0**
Proceedings of the 4th International Conference
on Mechanical Engineering (ICOME2019)

Yogyakarta, Indonesia • 28–29 August 2019

Editors • Suwarno, Vivien Djanali, Fahmi Mubarok
and Bambang Pramujati



INNOVATIVE SCIENCE AND TECHNOLOGY
IN MECHANICAL ENGINEERING
FOR INDUSTRY 4.0

Call for Applicants

Seeking New Editor-in-Chief

Applied Physics Letters





Conference Proceedings

HOME

BROWSE

MORE ▾

Table of Contents

INNOVATIVE SCIENCE AND TECHNOLOGY IN MECHANICAL ENGINEERING FOR INDUSTRY 4.0: Proceedings of the 4th International Conference on Mechanical Engineering (ICOME2019)

< PREV | NEXT >



Conference date: 28–29 August 2019
 Location: Yogyakarta, Indonesia
 ISBN: 978-0-7354-1934-6
 Editors: , Vivien Djanali, Fahmi Mubarok and Bambang Pramujati
 Volume number: 2187
 Published: Dec 10, 2019

DISPLAY : 20 50 100 all

PRELIMINARY

 No Access . December 2019

Preface: Innovative Science and Technology in Mechanical Engineering for Industry 4.0

more...

AIP Conference Proceedings 2187, 010001 (2019); <https://doi.org/10.1063/1.5138255>

⋮

ENERGY, HEAT TRANSFER AND FLUID FLOW

 No Access . December 2019

Numerical study on the performance and flow field of varied conical basin for efficient gravitational water vortex power plant

Didit Setyo Pamuji, Nizam Effendi and Daru Sugati

AIP Conference Proceedings 2187, 020001 (2019); <https://doi.org/10.1063/1.5138256>

SHOW ABSTRACT

⋮

 No Access . December 2019

The interactions of I-65° type cylinder and Savonius wind turbine for performance improvement

Gunawan Sakti, Triyogi Yuwono and Wawan Aries Widodo

AIP Conference Proceedings 2187, 020002 (2019); <https://doi.org/10.1063/1.5138257>

SHOW ABSTRACT

⋮



 No Access . December 2019

Effect of natural gas injection timing on combustion performance & methane slip emission of diesel - NG dual fuel engine: An experimental study

Betty Ariani, I. Made Ariana and M. Aguk Fathallah

AIP Conference Proceedings **2187**, 020003 (2019); <https://doi.org/10.1063/1.5138258>

SHOW ABSTRACT

⋮

 No Access . December 2019

Investigation of PEM fuel cell performance using the bio-inspired flow field combined with baffles on branch channels

A'rsy Fahrudin, Djatmiko Ichsan, Fadlilatul Taufany and Budi Utomo Kukuh Widodo

AIP Conference Proceedings **2187**, 020004 (2019); <https://doi.org/10.1063/1.5138259>

SHOW ABSTRACT

⋮

 No Access . December 2019

The experiment study of the performance of air heater solar collector type dimple inline plate v-corrugated absorber

Marsianus M. F. Hanmina, Djatmiko Ichsan and Mohammad Hakam

AIP Conference Proceedings **2187**, 020005 (2019); <https://doi.org/10.1063/1.5138260>

SHOW ABSTRACT

⋮

 No Access . December 2019

Effects of advancing injection timing on the engine performances and emissions of a diesel engine with 35% water in diesel emulsion fuel

Irvan Septian Krisandika, Bambang Sudarmanta and Rosid

AIP Conference Proceedings **2187**, 020006 (2019); <https://doi.org/10.1063/1.5138261>

SHOW ABSTRACT

⋮

 No Access . December 2019

Experimental study of performance of scroll type expander in organic rankine cycle (ORC) with R-141b working fluid

Deung Deriva, Prabowo and M. Yunus Abdullah

AIP Conference Proceedings **2187**, 020007 (2019); <https://doi.org/10.1063/1.5138262>

SHOW ABSTRACT

⋮

 No Access . December 2019

CFD simulations of complex fluid flow in gas-solid fluidized bed using modified $k-\epsilon$ turbulence models

Asyari Daryus, Ahmad Indra Siswantara, Budiarso, Budi Sumartono, Gun Gun R. Gunadi, Hariyotojo Pujowidodo and Candra D. Widiawaty

AIP Conference Proceedings **2187**, 020008 (2019); <https://doi.org/10.1063/1.5138263>

SHOW ABSTRACT

⋮

 No Access . December 2019

Unsteady simulations of Savonius and Icewind turbine blade design using fluid-structure interaction method



AIP Conference Proceedings 2187, 020009 (2019); <https://doi.org/10.1063/1.5138264>

SHOW ABSTRACT

⋮

 No Access . December 2019

Numerical simulation analysis of supersonic asymmetric converging-diverging nozzle with stepped curvature and curved discretization

Hariyotejo Pujowidodo, Ahmad Indra Siswantara, Budiarmo, Asyari Daryus, Gun Gun Ramdhan Gunadi and Candra Damis Widiawaty

AIP Conference Proceedings 2187, 020010 (2019); <https://doi.org/10.1063/1.5138265>

SHOW ABSTRACT

⋮

 No Access . December 2019

Numerical study of the characteristics of flow and heat transfer design of USC 1000 MW superheater boiler

Ronny C. Sirait and Prabowo

AIP Conference Proceedings 2187, 020011 (2019); <https://doi.org/10.1063/1.5138266>

SHOW ABSTRACT

⋮

 No Access . December 2019

Influence of water diesel emulsion on the performance and emission diesel engine under varying engine load

Abdul Wahid Arohman, Bambang Sudarmanta and Rosid

AIP Conference Proceedings 2187, 020012 (2019); <https://doi.org/10.1063/1.5138267>

SHOW ABSTRACT

⋮

 No Access . December 2019

Evaluation of thermal and hydraulic of air flow through perforated concave delta winglet vortex generators in a rectangular channel with field synergy principle

Syaiful, Pracayasa Ade Putra, Mohammad Tauviquirrahman, Nazaruddin Sinaga and Myung-whan Bae

AIP Conference Proceedings 2187, 020013 (2019); <https://doi.org/10.1063/1.5138268>

SHOW ABSTRACT

⋮

 No Access . December 2019

Experimental study effect of classifier pulverizer opening setting variation on fineness production passed 200 mesh

Imam Dwi Prasetyo and Prabowo

AIP Conference Proceedings 2187, 020014 (2019); <https://doi.org/10.1063/1.5138269>

SHOW ABSTRACT

⋮

 No Access . December 2019

Analysis and optimization of a 400 MW coal-fired power plant under a proposed low-rank coal with flue gas recirculation mode

I. Gede Darmadi and Budi Utomo Kuku Widodo

AIP Conference Proceedings 2187, 020015 (2019); <https://doi.org/10.1063/1.5138270>



SHOW ABSTRACT



 No Access . December 2019

Experimental study: The effect of the variation of the mill air fuel ratio on fineness in the pulverizer of the 600 MW Indonesian steam power plant

Bintoro Adi Nugroho and Djatmiko Ichsani

AIP Conference Proceedings **2187**, 020016 (2019); <https://doi.org/10.1063/1.5138271>

SHOW ABSTRACT



 No Access . December 2019

Numerical study of three-dimensional flow characteristics around the wing airfoil E562 with forward and rearward wingtip fence

Setyo Hariyadi Suranto Putro, Sutardi and Wawan Aries Widodo

AIP Conference Proceedings **2187**, 020017 (2019); <https://doi.org/10.1063/1.5138272>

SHOW ABSTRACT



 No Access . December 2019

Numerical study of dual fuel engine using proportional natural gas split injection

Frengki Mohamad Felayati, Semin, Beny Cahyono and Rosli Abu Bakar

AIP Conference Proceedings **2187**, 020018 (2019); <https://doi.org/10.1063/1.5138273>

SHOW ABSTRACT



 No Access . December 2019

Effect of B20 heating on the macroscopic fuel spray characteristic

Barokah, Semin, Faris M. Muhammad, Beny Cahyono and Saiful Irfan

AIP Conference Proceedings **2187**, 020019 (2019); <https://doi.org/10.1063/1.5138274>

SHOW ABSTRACT



 No Access . December 2019

An experimental investigation of natural gas injection timing on dual-fuel engine

Muhammad Badrus Zaman, Yudha Prasetyo and Semin

AIP Conference Proceedings **2187**, 020020 (2019); <https://doi.org/10.1063/1.5138275>

SHOW ABSTRACT



 No Access . December 2019

Numerical investigation of flow through a square duct with installed tripping rod inside on square elbow 90°

Ikki Adji Dharma, Wawan Aries Widodo and Randi Purnama Putra

AIP Conference Proceedings **2187**, 020021 (2019); <https://doi.org/10.1063/1.5138276>

SHOW ABSTRACT



 No Access . December 2019

Performances of three solar distillers with different absorbers

M. Mirmanto, M. Wirawan, I. M. A. Sayoga, A. T. Wijayanta, P. Pranowo, M. Faisal and A. Abdullah

AIP Conference Proceedings **2187**, 020022 (2019); <https://doi.org/10.1063/1.5138277>

SHOW ABSTRACT

⋮

 No Access . December 2019

Effect of natural gas injection pulse width to diesel dual fuel performance

Muhammad Badrus Zaman, Dimas Tegar Rahmatullah, Semin and Frengki Mohamad Felayati

AIP Conference Proceedings **2187**, 020023 (2019); <https://doi.org/10.1063/1.5138278>

SHOW ABSTRACT

⋮

 No Access . December 2019

Investigation the effect of superficial velocity to the heat transfer in bubbling regime of fluidization using CFD simulation

Candra Damis Widiawaty, Ahmad Indra Siswantara, Budiarmo, Asyari Daryus, Gun Gun Ramdhan Gunadi and Hariyotejo Pujowidodo

AIP Conference Proceedings **2187**, 020024 (2019); <https://doi.org/10.1063/1.5138279>

SHOW ABSTRACT

⋮

 No Access . December 2019

Force coefficient characteristics on a four circular cylinders in an in-line square configuration near a plane wall at "small gap"

A. Grummy Wailanduw, Triyogi Yuwono and Priyo Heru Adiwibowo

AIP Conference Proceedings **2187**, 020025 (2019); <https://doi.org/10.1063/1.5138280>

SHOW ABSTRACT

⋮

 No Access . December 2019

Optimization of CNG injection duration on combustions and emissions characteristics on CNG-CPO biodiesel dual fuel engine with load variations

Dori Yuvenda, Bambang Sudarmanta and Arif Wahjudi

AIP Conference Proceedings **2187**, 020026 (2019); <https://doi.org/10.1063/1.5138281>

SHOW ABSTRACT

⋮

 No Access . December 2019

Numerical study of flow characteristic and heat transfer on high-pressure turbine forced cooling process of sub critical steam turbine

Suyadi and Ary Bachtiar Krisna Putra

AIP Conference Proceedings **2187**, 020027 (2019); <https://doi.org/10.1063/1.5138282>

SHOW ABSTRACT

⋮



Thermodynamic investigation of automotive air conditioning system performance using ejector as an expansion device

Kasni Sumeru, Pratikto, Rachmad Imbang Tritjahjono and Mohamad Firdaus Sukri

AIP Conference Proceedings **2187**, 020028 (2019); <https://doi.org/10.1063/1.5138283>

SHOW ABSTRACT

⋮

 No Access . December 2019

Analysis of particulate dispersion in Suralaya coal-fired power plant

Vini Charloth, Wawan Aries Widodo and IDAA Warmadewanthi

AIP Conference Proceedings **2187**, 020029 (2019); <https://doi.org/10.1063/1.5138284>

SHOW ABSTRACT

⋮

 No Access . December 2019

Experimental study the effect of excess air to unburn carbon and boiler efficiency using coal with heating value 4200 kcal/kg at a 500 MW steam power plant

Imam Siswo Utomo and Djatmiko Ichsani

AIP Conference Proceedings **2187**, 020030 (2019); <https://doi.org/10.1063/1.5138285>

SHOW ABSTRACT

⋮

 No Access . December 2019

The effects of pilot injection timing on the combustion process and exhaust emissions in dual-fuel diesel engine using biodiesel-CNG at high load

Ahmad Arbi Trihatmojo, Dori Yuvenda and Bambang Sudarmanta

AIP Conference Proceedings **2187**, 020031 (2019); <https://doi.org/10.1063/1.5138286>

SHOW ABSTRACT

⋮

 No Access . December 2019

Numerical study effect of burner tilt angle on the boiler rear pass temperature on PLTU Banten 1 Suralaya under LRC coal conditions

Nugroho Setyo Hutomo and Arif Wahjudi

AIP Conference Proceedings **2187**, 020032 (2019); <https://doi.org/10.1063/1.5138287>

SHOW ABSTRACT

⋮

 No Access . December 2019

Numerical simulation of coal particle size (fineness) effect to combustion characteristics of sub-critical pulverized coal boiler 600 MW capacity

Heri Purnomo and Bambang Sudarmanta

AIP Conference Proceedings **2187**, 020033 (2019); <https://doi.org/10.1063/1.5138288>

SHOW ABSTRACT

⋮

 No Access . December 2019



SHOW ABSTRACT



 No Access . December 2019

Analysis of an optimum method for power generation using flare gas from oil refinery plants

Bambang Arip Dwiyantoro and Farai William Saungweme

AIP Conference Proceedings **2187**, 020035 (2019); <https://doi.org/10.1063/1.5138290>

SHOW ABSTRACT



 No Access . December 2019

Numerical analysis of conjugate porous media for increasing heat transfer rate in fixed bed spheres

Farida Rahmawati Purnadiana, Prabowo and Herman Sasongko

AIP Conference Proceedings **2187**, 020036 (2019); <https://doi.org/10.1063/1.5138291>

SHOW ABSTRACT



 No Access . December 2019

Flow structure investigation heat transfer enhancement on inner tubular pipe with winglet vortex generator

Stefan Mardikus, Malfin and I. Made Wicaksana Ekaputra

AIP Conference Proceedings **2187**, 020037 (2019); <https://doi.org/10.1063/1.5138292>

SHOW ABSTRACT



 No Access . December 2019

Numerical study on in-furnace blending coal combustion characteristics in a 625 MW tangentially fired pulverized coal boiler

Fajar Purnomo and Atok Setiyawan

AIP Conference Proceedings **2187**, 020038 (2019); <https://doi.org/10.1063/1.5138293>

SHOW ABSTRACT



 No Access . December 2019

Experimental and numerical study on the boundary layer flow over a flat plate with a semi-circular bump with and without a transversal wire

S. Sutardi, Radiaprima Kartika Wijaya and Setyo Hariyadi

AIP Conference Proceedings **2187**, 020039 (2019); <https://doi.org/10.1063/1.5138294>

SHOW ABSTRACT



 No Access . December 2019

Ratchet flywheel regenerative system to enhance energy captured for electric vehicle

Agung Prijo Budijono, I. Nyoman Sutantra and Agus Sigit Pramono

AIP Conference Proceedings **2187**, 020040 (2019); <https://doi.org/10.1063/1.5138295>



Flow Structure Investigation Heat Transfer Enhancement on Inner Tubular Pipe with Winglet Vortex Generator

Stefan Mardikus^{a)}, Malfin, I Made Wicaksana Ekaputra

Sanata Dharma University, Yogyakarta, Indonesia

^{a)}stefan@usd.ac.id

Abstract. Vortices phenomenon becomes one of solutions to enhance heat transfer performance in shell-and-tube type of heat exchanger. Vortex generator is a device that can generate moving vortices of fluid to get good mixing fluid in heat transfer. The aim of this study is to find the effect of rectangular and delta winglet vortex generator if they are applied in inner tubular pipe heat exchanger, especially for shell-and-tube heat exchanger. Two types of winglet vortex generator were mounted in inner circular pipe then examined in turbulent flow with 6000-10000 Reynold numbers. The result of simulation showed that the use of rectangular and delta winglet can improve heat transfer performance.

INTRODUCTION

In Recent years, Heat Exchanger is a device to transfer heat in fluid thermal condition. Heat exchanger is more important in industrial such as power plant, air conditioning system, food technology and energy storage system. Shell-and-tube is one of types heat exchanger. Development of innovation to augment heat transfer performance on shell and tube heat exchanger is still being invented. Vortices phenomenon appears in flow structure to generate the heat transfer coefficient with the use of vortex generator. Vortex generator is passive technology to increase fluid mixing in heat transfer through different region between high pressure to low pressure when flow of the fluid hits the vortex generator. Through this indication, the tendency of heat transfer coefficient as one of the performance parameters is increasing. However, the use of vortex generator can produce high pressure drop while Nusselt number goes up[1]. Better efficiency, compact design, good heat transfer, and low pressure drop are main requirement of heat exchanger. Several types of vortex generator like rectangular, delta, trapezoidal can use longitudinal vortices. To enhance heat transfer performance in shell-and-tube type, vortex generator is mounted in circular pipe to result increasing of mixing thermal. Based on characteristic of distinguish, vortex generator contains of two motion in flow structure such as vortices of transverse and streamwise. In transverse, flow recirculation is behind of vortex generator then motion of rotation to direction flow as perpendicular while in streamwise, move swirling to flow direction [2]. Study about characteristic of vortex generator in open channel always develop like as Zhiming Xu studies about effect of vortex generator in rectangular channel to performance of heat transfer and flow resistance [3]. Through design and arrangement like as radius, spacing, vortex generator can augment thermal hydraulic performance. as above mentioned, problem studies about vortex generator in open channel were always investigated to optimal performance in any conditions. The present study will be simulated that compare of vortex generator types such as rectangular and delta winglet vortex generators in inner tubular pipe using R-12 as working fluid. Through this simulation, effect of vortex generator can be founded to get the best performance from use of vortex generator types.

MODEL AND COMPUTATIONAL DESCRIPTIONS

The circular tube with delta and rectangular winglet vortex generators is described in Fig. 1. The arrangement of winglet vortex generator consisting of 6 rows and each row have 4 winglet pairs of vortex generator with distance between one pair with another pairs of winglet vortex generators of 100 mm. The diameter of inner circular tube is 47.8 mm with 700 mm as the length of circular pipe. For rectangular and delta winglet vortex generators, isometric view and detail sizing are performed within Fig. 2. The boundary condition for this simulation was illustrated that range Reynold number started from 6000 to 10000 with 1000 as interval. The turbulence model was applied in this simulation using k-omega and R-12 was used as fluid [4].

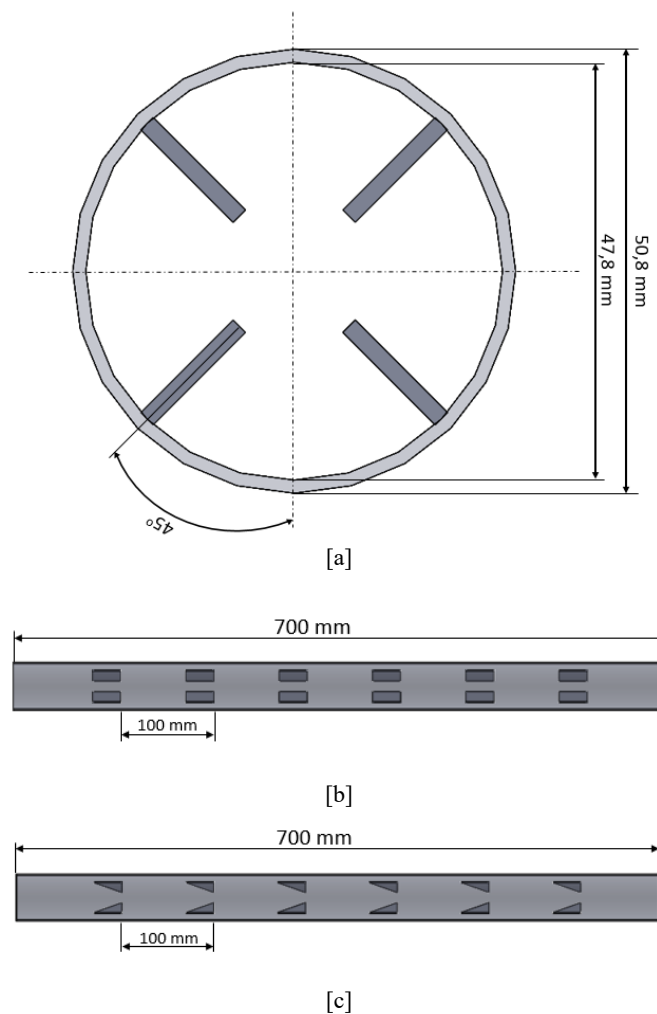

FIGURE 1. a. diameter description in right view of circular tube, b. front view rectangular and delta winglet vortex generators in circular tube of pipe length descriptions.

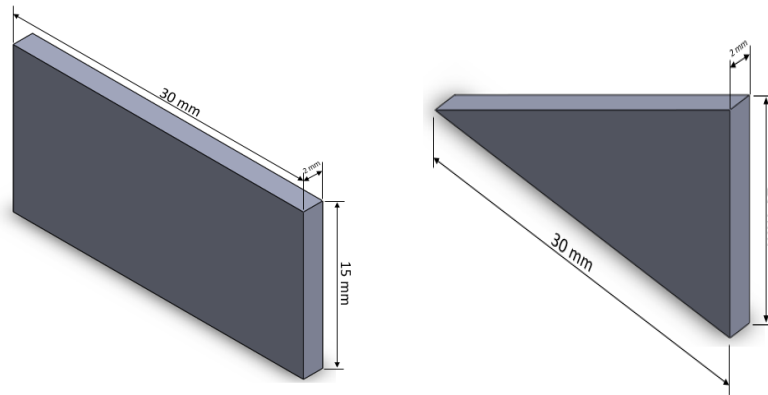

FIGURE 2. Isometric view of rectangular and delta winglet vortex generator

RESULT AND DISCUSSION

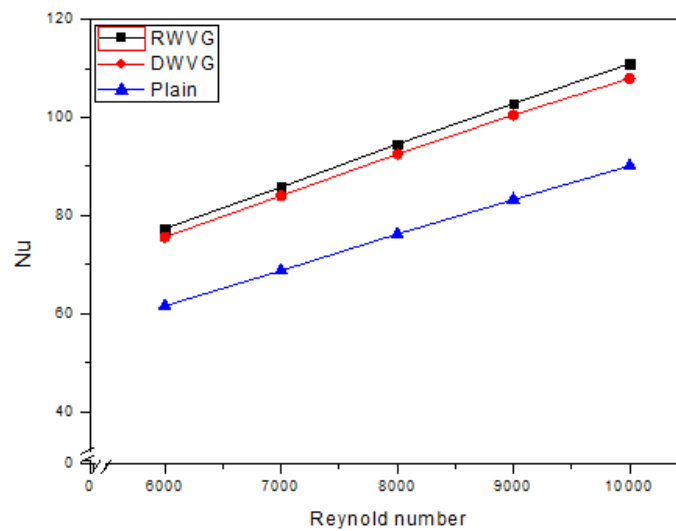

FIGURE 3. Correlation of Reynolds number and Nusselt number for different vortex generators

Figure 3 indicated that Nusselt number of rectangular and delta winglet vortex generators significantly increase higher than without vortex generator. This case means that use of vortex generator could improve heat transfer performance on circular pipe because it can make more good of thermal mixing in circular pipe and modify boundary layer. Moreover, longitudinal vortices that generated by rectangular and delta winglet vortex generator can increase fluid mixing intensity, thus; the heat transfer will be occurred on low thermal fluid [4][5] .

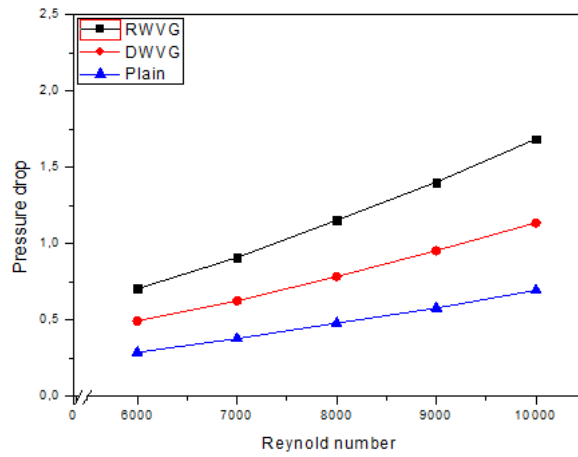

FIGURE 4. Correlation of Reynolds number and pressure drop for different vortex generators

In Fig 4, pressure drop purposes to know the disadvantages of fluid flow that pass into cylinder pipe as consequence addition of vortex generator. The use of rectangular and delta winglet vortex generators generated high flow resistance on fluid flow that pass vortex generator and wake phenomenon in behind of vortex area so the pressure drop was increase. The highest of pressure drop occurred on rectangular winglet vortex generator than delta winglet vortex generator and without vortex generator[6][5].

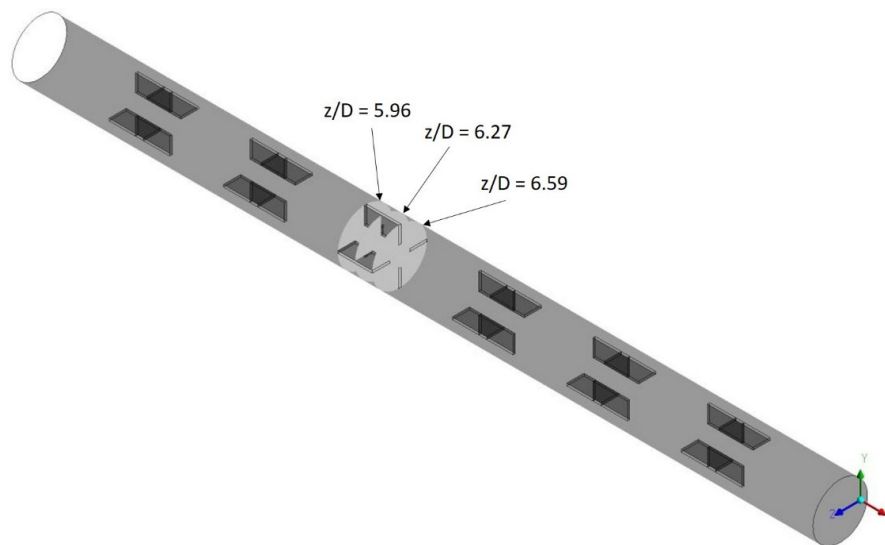

FIGURE 5. Schematic of 3 cross sectional area ($z/D = 5.96$; $z/D = 6.27$; $z/D = 6.59$)

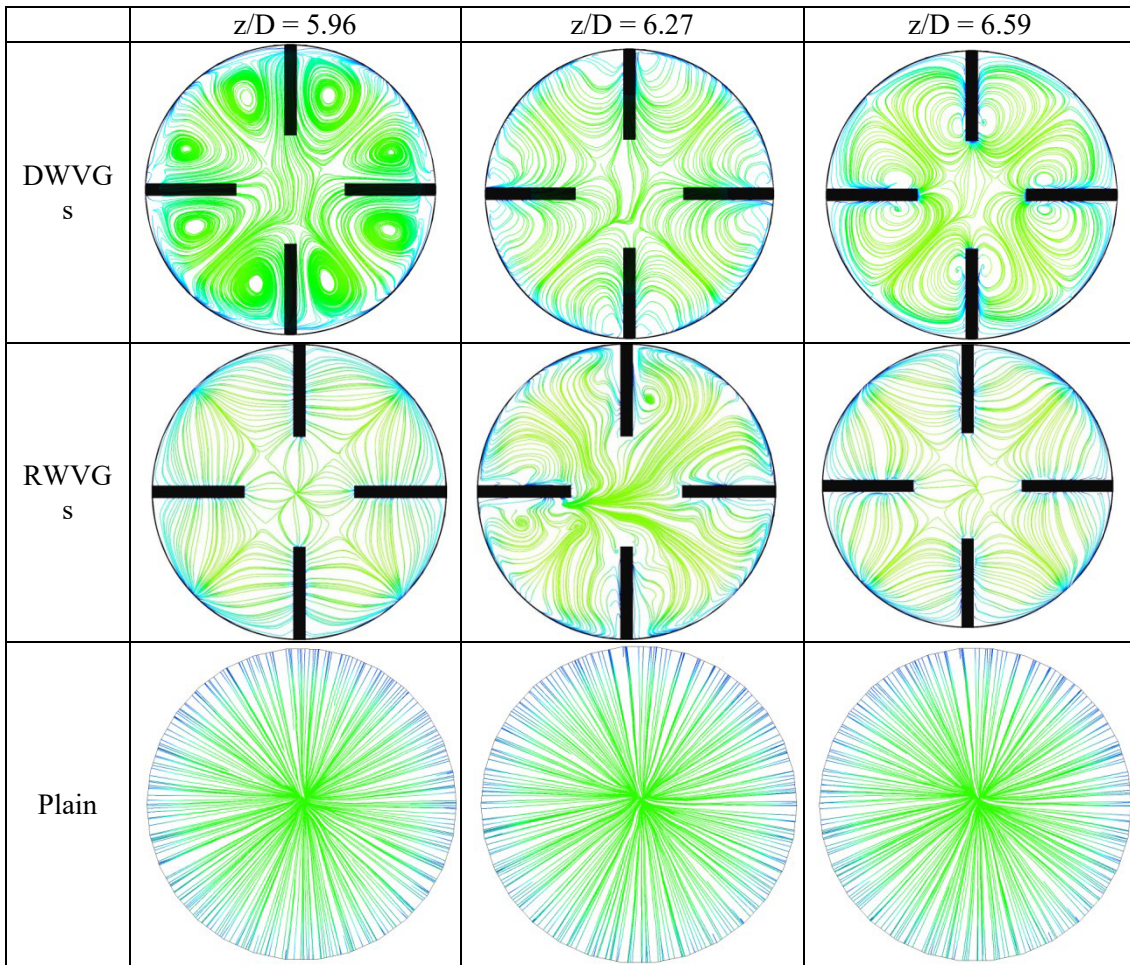

FIGURE 6. Streamline for $Re = 6000$ at 3 cross section

Wake on vortex generator which is area of low momentum flow will interact with flow core as high momentum flow that can become high pressure as the phenomenon of counter rotating vortex formation which have effect of temperature gradient increasing and heat transfer coefficient [7]. In Fig 6, wake phenomenon could be seen on DWVGs and RWVGs. For DWVGs and RWVGs, vortices appeared on the pipe wall, thus; it produced heat transfer enhancement because highest turbulent kinetic energy and thermal mixing improvement in wake regions [8][9].

CONCLUSION

Result of investigation about simulation of heat transfer performance in circular pipe with two types vortex generator, rectangular and delta winglet types was performed using computational fluid dynamic. Nusselt number and pressure drop parameters were used to represent heat transfer performance. Moreover, contour of temperature distribution and streamline velocity were used to identify the characteristic of flow structure in heat transfer enhancement. The primary conclusion was summarized as follow as;

1. The use of rectangular and delta winglet can improve performance of heat transfer by Nusselt number parameter. Moreover, this identification showed that use of rectangular winglet vortex generator had the highest Nusselt number more than delta winglet vortex generator and without vortex generator in circular pipe.
2. Wake region appeared when use of delta and rectangular vortex generator in cylinder pipe because highest turbulent kinetic energy and thermal mixing improvement that can increase heat transfer coefficient.

REFERENCES

1. S. Chamoli, R. Lu, J. Xie, and P. Yu, *Appl. Therm. Eng.*, vol. 135, pp. 304–324 (2018).
2. C. Habchi *et al.*, *Appl. Therm. Eng.*, vol. 38, pp. 14–25 (2012).
3. Z. Xu, Z. Han, J. Wang, and Z. Liu, *Int. J. Heat Mass Transf.*, vol. 116, pp. 61–72 (2018).
4. Y. Lei, F. Zheng, C. Song, and Y. Lyu, *Int. J. Heat Mass Transf.*, vol. 111, pp. 299–311 (2017).
5. Y. Xu, M. D. Islam, and N. Kharoua, *Int. J. Therm. Sci.*, vol. 112, pp. 304–317 (2017).
6. Z. Han, Z. Xu, and J. Wang, *Int. J. Heat Mass Transf.*, vol. 126, pp. 993–1001 (2018).
7. C. Habchi and J. L. Harion, *Int. J. Heat Mass Transf.*, vol. 74, pp. 13–24 (2014).
8. G. Liang, M. D. Islam, N. Kharoua, and R. Simmons, *Int. J. Therm. Sci.*, vol. 134, no. June, pp. 54–65 (2018).
9. G. Zhou and Z. Feng, *Int. J. Therm. Sci.*, vol. 78, pp. 26–35 (2014).